



BYRON

76.5" Model | 2 Seat Swing

OUTDOOR LIVING, ELEVATED

BYRON

76.5" Model | 2 Seat Swing

SKU MODEL
SK76B2

FEATURES

- No assembly required
- 2 strands of 1" synthetic manila rope

UPGRADES

- Furniture cover is available
- Additional rope options available: black and white

TECHNICAL DETAILS

Net weight 215 lbs.

PRODUCT INFO

- Premium unfinished teak frame - other teak finishes available
- Quick dry cushion set is available in Sunbrella fabrics or COM
- COM requirement: 12 yards

DIMENSIONS

| | |
|------------------------------------|---------|
| Depth (D) | 39.0 in |
| Seat depth with back cushion (SDC) | 32.0 in |
| Width (W) | 76.5 in |
| Seat width (SW) | 70.0 in |
| Height (H) | 25.0 in |

INSTALLATION HANG POINTS - 4 Point Application

| | |
|------------------------|---------|
| Hang point depth (HPD) | 34.0 in |
| Hang point width (HPW) | 80.0 in |

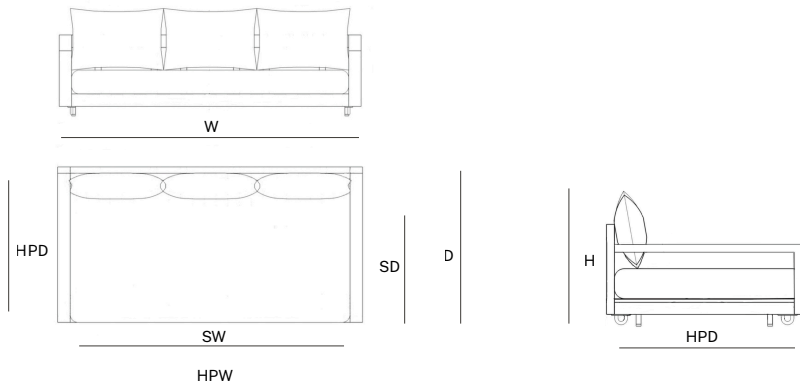

FRAME COLOR OPTIONS



Teak

FABRIC COLOR OPTIONS

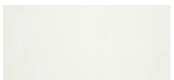

White

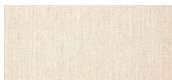

Pumice

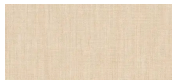

Flax

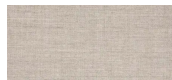

Silver

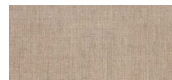

Ash

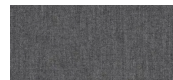

Charcoal



BYRON

86.5" Model | 3 Seat Swing

OUTDOOR LIVING, ELEVATED

BYRON

86.5" Model | 3 Seat Swing

SKU MODEL
SK86B3

FEATURES

- No assembly required
- 2 strands of 1" synthetic manila rope

UPGRADES

- Furniture cover is available
- Additional rope options available: black and white

TECHNICAL DETAILS

Net weight 235 lbs.

PRODUCT INFO

- Premium unfinished teak frame - other teak finishes available
- Quick dry cushion set is available in Sunbrella fabrics or COM
- COM requirement: 13 yards

DIMENSIONS

| | |
|------------------------------------|---------|
| Depth (D) | 39.0 in |
| Seat depth with back cushion (SDC) | 32.0 in |
| Width (W) | 86.5 in |
| Seat width (SW) | 80.0 in |
| Height (H) | 25.0 in |

INSTALLATION HANG POINTS - 4 Point Application

| | |
|------------------------|---------|
| Hang point depth (HPD) | 34.0 in |
| Hang point width (HPW) | 90.0 in |

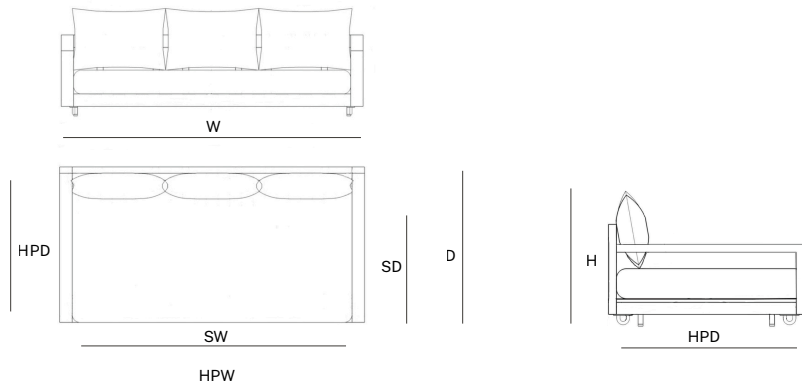

FRAME COLOR OPTIONS



Teak

FABRIC COLOR OPTIONS

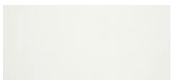

White

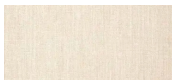

Pumice

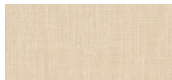

Flax

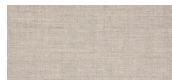

Silver

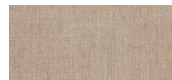

Ash

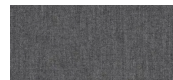

Charcoal